

OWNERS MANUAL



TOURER CANVAS SERIES



Complete Model Line-up

Product Code - CTT-09-E

Thank you for purchasing a superior OZtrail product. Please keep this Owners Manual in a safe and dry place, it contains important and helpful information.

IMPORTANT

We recommend that you set up this product before you leave for your trip. Check that all parts are present and that you familiarise yourself with the assembly and disassembly of the product. If you have any problems, your OZtrail dealer will be able to sort it out for you.

You should have the following parts: -

Product Code - CTT-09-E

PART DESCRIPTION

- 1 x Adjustable Centre Pole (410)
- 4 x Elbow Poles for Roof Frame (055)
- 2 x Steel Awning Poles (201)
- 1 x Tent Carry Bag
- 1 x Pole Bag
- 1 x Peg Bag
- 6 x Guy Ropes
- 2 x Rubber Centre Pole Caps
- 18 x Pegs

PLEASE NOTE - Due to our policy of continual product development, specifications and features of the product may vary from details within this Owners Manual.

Product And Parts

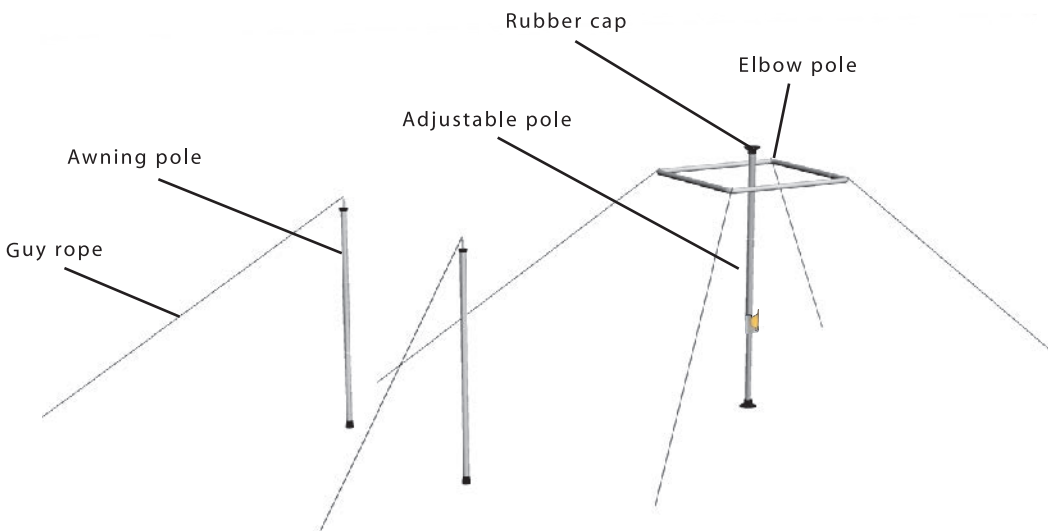

Product Code - CTT-09P-E , CTT-10P-D & CTT-TTW-D

**Thank you for purchasing a superior OZtrail product.
Please keep this Owners Manual in a safe and dry place, it
contains important and helpful information.**

IMPORTANT

We recommend that you set up this product before you leave for your trip. Check that all parts are present and that you familiarise yourself with the assembly and disassembly of the product. If you have any problems, your OZtrail dealer will be able to sort it out for you.

You should have the following parts: -

Product Code - CTT-09P-E , CTT-10P-D

PART DESCRIPTION

- 1 x Adjustable Centre Pole (410)
- 4 x Elbow Poles for Roof Frame (055)
- 1 x Complete Rear Ridge pole 305
- 2 x Steel Awning Poles (201)
- 2 x 90° Elbow Pole with Stud 051
- 2 x Fixed Length Pole 101
- 1 x Tent Carry Bag
- 1 x Pole Bag
- 1 x Peg Bag
- 6 x Guy Ropes
- 2 x Rubber Centre Pole Caps
- 18 x Pegs

PLEASE NOTE - Due to our policy of continual product development, specifications and features of the product may vary from details within this Owners Manual.

Product And Parts

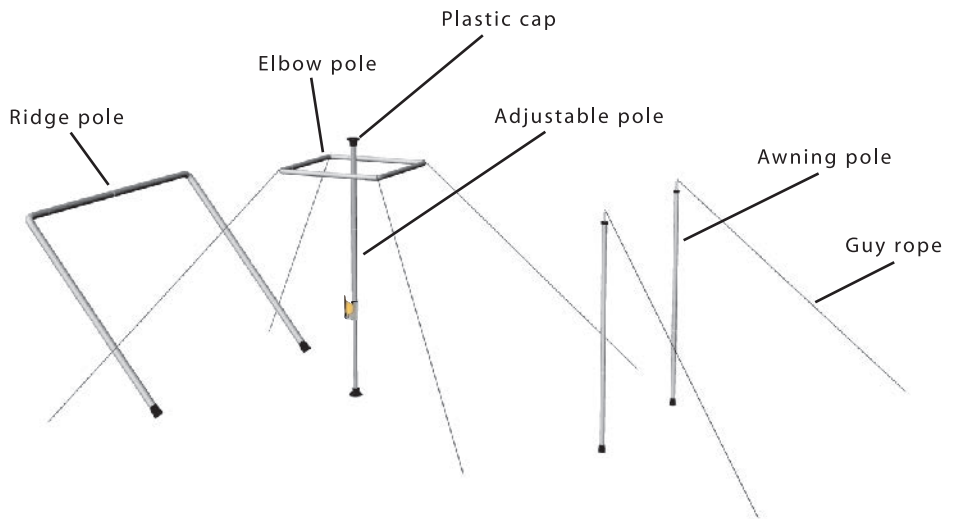

ASSEMBLY INSTRUCTIONS

STEP 1:

Select a sheltered camp site protected from the wind that will not allow water to pond under the tent Floor. Clear a level area of all stones, twigs, etc.

STEP 2:

Lay out the tent and position it so the doors face the desired direction and peg the corners down.

STEP 3:

Select the 4 x Roof Frame Elbow Poles (See Figure 1). Open the door of the tent, turn the roof inside out through the doorway. Assemble the poles inside the roof pole sleeves (See Figure 2 A,B,C,D). The roof must be relaxed and not under any tension for this step. Take care ~ you do not have to use any force to do this step. Make sure the pole sections do not snag on the sleeve fabric.

STEP 4:

Installing the centre pole. Assemble the 3-piece centre pole (See Figure 1). Make sure that the protective rubber caps are on each end. With the door wide open to prevent suction when lifting, place the pole in the centre of the roof and raise the tent with the pole. Your helper can adjust the pole length adjustment lock on the lower part of the pole to make sure the pole fits firmly against the centre of the floor.

STEP 5: Tourer Plus Models Only

Select the 2 piece section of ridge pole without plastic base caps and slide through fabric loops along join in roof and wall at rear of tent. Select and attach the 2 corner pole sections to the 2 piece ridge pole described above and tie off with corner webbing straps. Select the 2 remaining 2 piece upright sections of ridge pole with plastic base caps, connect to the corner pole section, position the upright section of the ridge pole to support the rear roof section, firm but not tight. see figure 3.

STEP 6:

Peg out all remaining peg loops and ensure all peg down points are utilised. Attach the guy lines provided to the loops located on the upper corners of the tent, and peg out as far as possible.

STEP 7:

To erect the awnings first open the front entrance. With the 2 awning poles provided, insert the spigot (spike) on top of the poles into the eyelets located at the corners of the awning. Attach the guy lines to the top of the spigot and peg the line out at 45 degrees.

IMPORTANT

1. After unpacking the tent, use the check list on page 4 to make sure you have all the parts.

2. You need to condition your Canvas tent/shelter before use.

See page 12 - CONDITIONING YOUR NEW CANVAS TENT/SHELTER

Figures And Illustrations

Figure 1

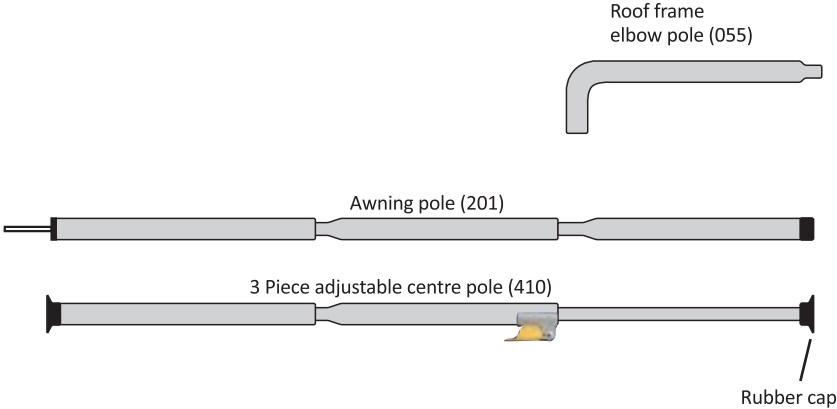

Figure 2

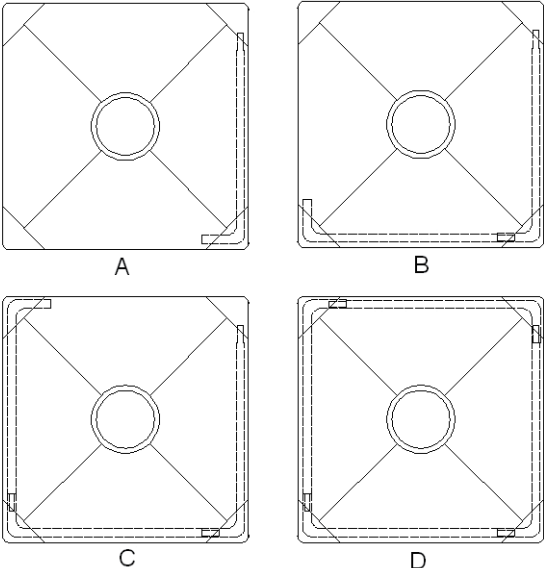
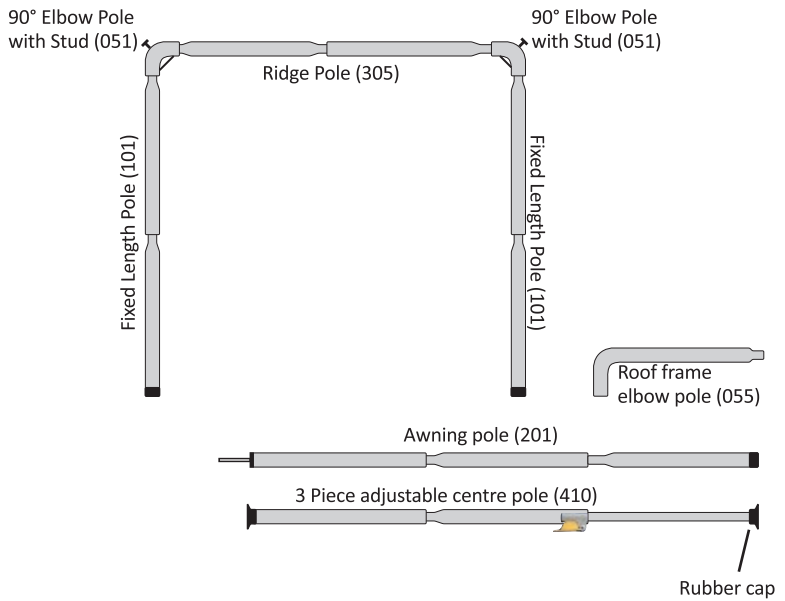

Figure 3



Disassembly Instructions

STEP 1:

Release guy ropes.

STEP 2:

Unzip doors and windows and collapse the tent, removing and disassembling the poles, except the roof elbow poles (See Figure 2) that remain in the tent. Place the poles in the pole carry bag and tie shut. You can either leave the Roof Frame Poles assembled or disassemble and remove from the tent.

STEP 3:

Remove pegs and place in the peg carry bag and tie it shut

STEP 4:

Spread the tent out flat with all loose fabric within the edges of the tent base. Try to flatten the tent as much as possible.

STEP 5:

- a) If you leave the roof poles in, fold the tent into the centre around the roof elbow poles. The folded tent should be slightly less than the tent carry bag (See Figure 4).
- b) If you take the roof poles out (See Figure 5).

STEP 6:

When the tent is folded up, place into tent carry bag with peg bag, pole bag, instruction sheet, and other miscellaneous parts. If tent does not fit into carry bag, unfold and refold more tightly.

Important

Do not store your tent away wet, damp or dirty. If you have no choice but to return home from your camping trip with a wet, damp or dirty tent, make sure you lay it out to air in a cool, dry and shaded place and only pack it away when it is completely dry and clean.

**Do not remove pegs from the ground by pulling on peg loops.
This may cause the peg loops to tear out of the seam.**

Folding Instructions

Figure 4

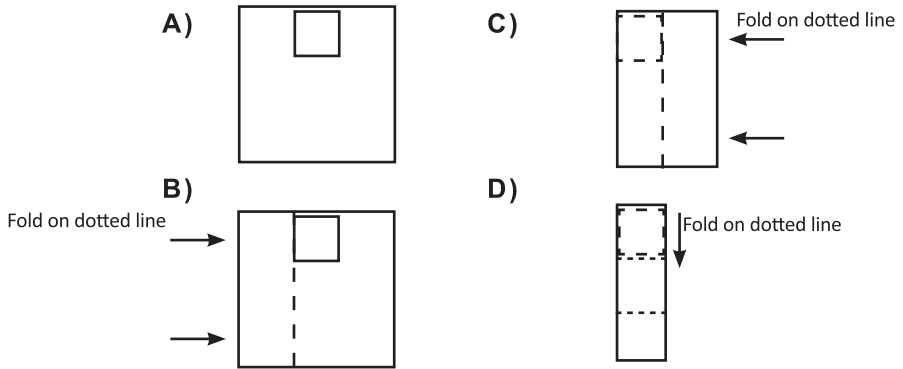
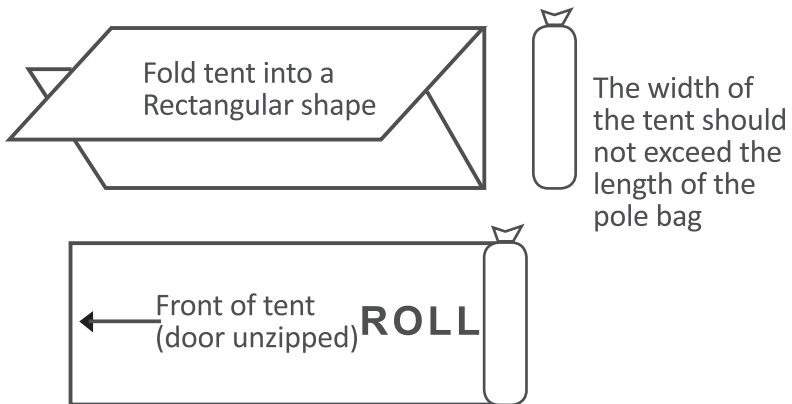

Figure 5



Warranty

OZtrail warrants this product against defects for a period of two years from the date of purchase. OZtrail will repair or replace the product, at its discretion, should a warrantable defect arise within the warranty period. If the exact model is unavailable a model of equivalent nature will be substituted at our discretion. This warranty excludes faults and failures caused by improper use and abuse; fair wear and tear; or failure to follow instructions regarding care and maintenance. Products used for a commercial nature are not covered by this warranty against defects. A warranty may be claimed by returning the product to its place of purchase, with a detailed proof-of- purchase clearly showing the date and detail of the purchase. You may also contact OZtrail Leisure Products, by phone: 07 3193 1110, or in writing: PO Box 1110, Eagle Farm QLD 4009, by email: warranty@oztrail.com.au. The benefits under OZtrail's warranty against defects are in addition to other rights and remedies under law in relation to goods.

Our goods come with guarantees that cannot be excluded under the Australian Consumer Law. You are entitled to a replacement or refund for a major failure and for compensation for any other reasonably foreseeable loss or damage. You are also entitled to have the goods repaired or replaced if the goods fail to be of acceptable quality and the failure does not amount to a major failure.

For more detailed information and an explanation of these terms see www.oztrail.com.au/warranty

Important: This tent is to be assembled once before going camping to ensure that all parts are present and to become familiar with the assembly of the tent.

Your product is valuable and should be insured against loss or damage. During strong winds and storms collapse the tent flat onto the ground and seek refuge in your vehicle. Damage caused by storms and strong winds is not covered by warranty.

EXTREME CAUTION - Gas, fumes or lack of oxygen within the tent/shelter could result in unconsciousness, brain damage and even death

PROLONGING THE LIFE OF YOUR TENT/SHELTER

- Intermittent use only. Although our fabrics are treated for extra UV resistance, continuous exposure to sun light will break the fabric down. Fading of colour is an early warning sign. These tents/shelters are not designed as permanent dwellings or structures.
- During rain always lower awnings to avoid water ponding and collapsing the awning.
- If seam seal tape is lifting, simply cut the lifted tape off and apply seam sealer to the seam.
- Never store a wet and/or soiled tent/shelter; as mildew and corrosion can form within a few days. This condition is not covered by the warranty. Always allow the tent to dry completely before packing and stowing. If mildew occurs, use a soft bristle brush or sponge with mild detergent to clean it off.
- The elastic shock cord within the poles is provided for easy assembly of the poles. The shock cord is not required for any structural reason. The poles and tent perform perfectly well without the shock cord. Age, over stretching and mishandling may cause failure. Shock cord is not covered by warranty. It's easy to replace, see instructions.
- Sometimes the zipper coil bursts open or does not close. This could be due to wear or metal fatigue. The problem can be easily fixed, see instructions.
- First aid for tears and ash burns is to carry a roll of tape, industrial or medical. This not only blocks the hole, it will prevent further tearing. It could have other uses around the camp site too.
- When removing pegs, do not use the webbing or corner of the tent as your handle. Either use another peg, a peg remover or the claw of a hammer hooked under the peg to remove them.

IMPORTANT - CONDITIONING YOUR NEW CANVAS TENT

Once you get your new tent home, it is important to condition the tent. Simply pitch your tent and wet it down with your garden hose. Pay particular attention to the seams - the thread swells when wet and blocks the needle holes. The needle holes also shrink around the thread. The canvas fabric also benefits from this because the cotton swells into the weave and the waterproof treatment settles within the fabric. Let the tent dry completely before doing it a second time. Always pack your tent away dry.

UNDERSTANDING WATERPROOFNESS

What is not covered by warranty!

OZtrail tents use waterproof and water repellent fabrics. However, with the addition of seams, zips and other desirable features a recreational tent will not be as waterproof as a car, house or other solid structures. The following are common examples of how water can enter a tent: -

Condensation - When warm moist air meets cooler air, condensation occurs. The tent/shelter fly forms an impermeable layer between the inside and outside conditions. The moisture inside the tent/shelter condenses on the fabric. Sometimes in cold conditions it appears that the fabric is leaking when in fact the cause is condensation. Condensation can be reduced if the tent/shelter is well ventilated.

Zips - All care is taken in the design to cover zips with rain flaps. At times wind driven rain could force water under the rain flaps and through the zips. To minimise this, make sure all doors and windows are closed with the rain flaps covering the zips.

Floor - If the ground is very wet or water pools under the floor, downward pressure of standing or kneeling on the floor could force water through the floor fabric. To prevent this, do not pitch the tent over hollows and make sure water drains away from the tent.

Structural Integrity - A perfectly pitched tent on perfectly flat ground is structurally strong and most waterproof. During prolonged periods of rain and wind it may be necessary to tighten guy lines and reset the tent pegs and attend to drainage around the tent. Sagging and incorrect pitching weakens the tent structure and could allow water to pool on the fly placing undue forces on the tent causing leaking and breakages.

Zips

Reducing the risk of jamming fabric in the zip ~

- When using the zip, hold the pull-tab between your thumb and forefinger with your thumb facing you.
- As you are closing the zip clear the way in front and under the zip slider using the back of your hand, and cup the zip slider underneath with your remaining 3 fingers.

Use this action for opening or closing. Keep the fabric clear of the zip slider - zip and unzip slowly.

What to do when the zipper gets caught ~

- Pull the fabric bit by bit out of the slider. Do not try and pull all the fabric in one go. Do not force the slider, or use pliers on either the fabric or the zip.

If the slider does not close the zipper properly ~

- With use, the jaws of the zip slider can open ever so slightly. When this occurs the slider does not compress the zip teeth or coil together tightly enough and the zip bursts open or does not close.
- Undo the zip and with the slider at the end of the zip lightly crimp the jaws of the slider together. Try top to bottom axis first and then side to side axis.

Crimping A Zip-Slider

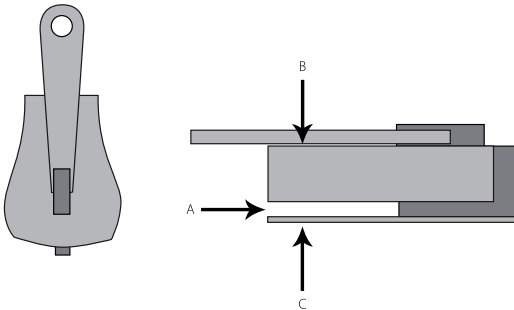

The most common reason why zips burst open is that the zip slider does not close the coil tightly enough. Metal fatigue and production variances cause the gap marked A to open up.

By simply 'crimping' the slider together at points B & C with a pair of pliers, this solves the problem most of the time. Crimping in other planes is worth a try if B & C does not work. This is to be done when the zip slider is still attached to the zip in the open position.

Important Safety And Care Information

PLEASE READ BEFORE SETTING UP YOUR TENT/SHELTER

CAMP SAFE - SAFETY HABITS

The fabric may burn if left in continuous contact with a flame from any source. Also, the application of any foreign substance to the tent fabric may render the flame resistant properties ineffective.

To prevent injury caused by gas poisoning or suffocation -

- Do not use fuel burning, oxygen consuming devices inside the tent. This includes candles,
- Do not use gas appliances of any kind inside the tent/shelter

To prevent injury caused by fire -



- Do not pitch the tent/shelter near a camp fire or any other flame source
- Do not use candles, matches or any other flame source in or near the tent (this includes stoves, cooking equipment, lighting and heating appliances)
- Only use recommended water repellent compounds on the tent/shelter fly
- Do not spray tent fabrics with insecticides



To prevent injury caused by electricity -

- Always exercise care when using electricity and electric lighting in and near tents/shelters. Only use 12 volt lighting.

To prevent injury caused by your camping environment -



- Do not pitch your tent/shelter on an area that could get flooded



- Do not leave your tent/shelter erected in strong winds - collapse the tent onto the ground and seek refuge in your vehicle



- Do not pitch your tent/shelter near cliffs in case of collapse or rock fall



- Do not pitch your tent/shelter under trees with dead branches or under trees known to drop branches



See our website for the full OZtrail range or

 facebook.com/OZtrailAustralia.

Made in Bangladesh
Designed & Imported by:
OZtrail Leisure Products
71 Charles Ulm Place, Eagle Farm
QLD 4009, AUSTRALIA

www.oztrail.com